

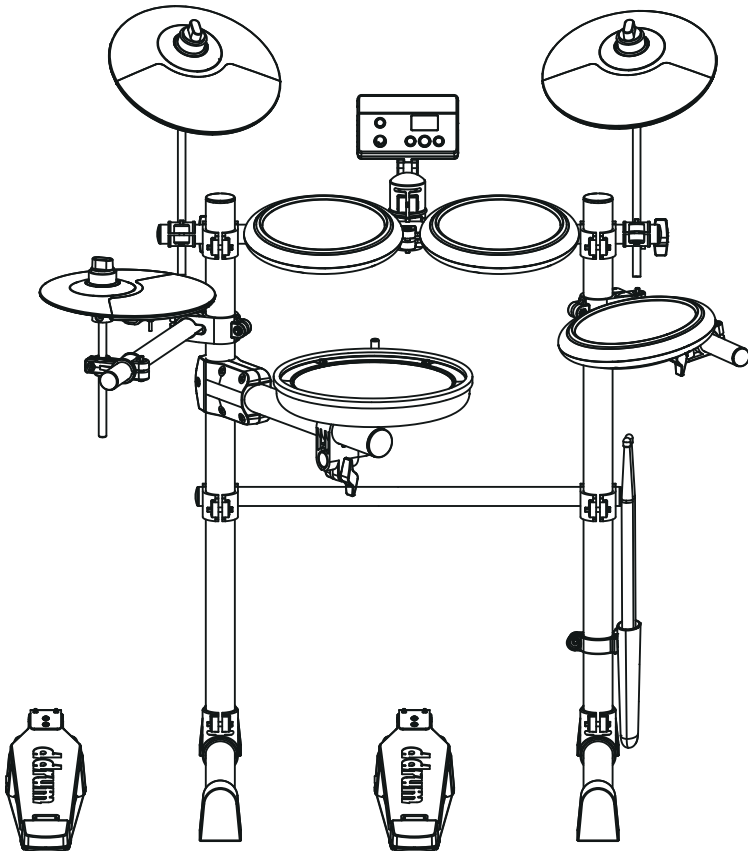

# E-FLEX

Electronic Drum Set



## USER MANUAL



MADE IN CHINA



# Table of Contents

<b>Product Features</b> .....	4
<b>Drum Introduction</b> .....	5
<b>Basic Playing</b> .....	6
<b>Module Introduction</b> .....	7
<b>How to Operate</b> .....	8
<b>Pedal Adjustment and Button Functions</b> .....	9
<b>USB MIDI</b> .....	10
<b>Specifications</b> .....	11



---

Thank you for purchasing the ddrum E-Flex Electronic Drum Set. Please refer to the Assembly Instructions to setup the ddrum E-Flex Electronic Drum Set. Before you start playing, please read through this manual.

## **Product Features**

### **ddrum E-Flex Configuration**

The ddrum E-Flex electronic drumset comes complete with 3 tom pads, snare pad, 3 cymbal pads, hi-hat & bass drum controller, throne and drum sticks.

### **Updated Mesh Drum Heads**

All of the pads including the snare drum use mesh heads, which feel better and are more quiet than standard rubber pads.

### **Easy to use Module**

The ddrum E-Flex module is designed to be easy to use. It has one volume knob, two drum sound switch buttons, and one metronome button.

### **Metronome function**

The ddrum E-Flex includes a built in metronome. Range is 40-240 BPM.

# Drums Introduction

## Crash cymbal

Reference: CR. 9" diameter. The crash cymbal should be positioned at the left side of the drum rack. The crash cymbal includes choke function.

## Ride cymbal

Reference: RD. 9" diameter. The ride cymbal should be positioned at the right side of the drum rack. The ride cymbal includes choke function and has separate bell zone.

## Hi-Hat

Reference: HH. 9" diameter. The Hi-hat pad is to be positioned on the left side of the rack on lower rack arm. (See Diagram 1)

## Toms

Reference: T1, T2, T3. 6" diameter mesh tom pads. The tom pads mount to the center and right side rack arms. The mesh heads provide great feeling and quiet sound.

## Snare drum

Reference: SD. 6" diameter dual mesh snare pad. The snare pad should be mounted to the third rack arm down on the left side and positioned towards the center like a snare drum. The snare pad includes a dual zone function for side sticking sound option.

## Bass drum

Reference: BD. The bass drum on the E-Flex is activated by a bass drum controller. The user simply presses on the pedal to make a bass drum sound.

## Hi-Hat pedal

Reference: HHP. The hi-hat controller is similar to the bass drum controller. Similar to a real hi-hat stand, simply press the controller to make open and closed hi-hat sounds.

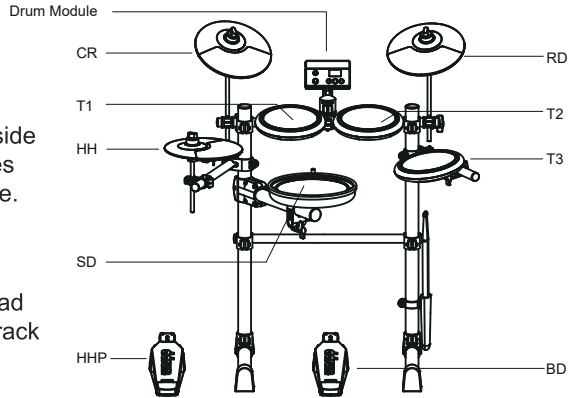

Diagram 1

**Reminder:** The reference abbreviation is marked on each pad and the end of each cable for easy setup.

# Basic Playing

This is a brief overview of how to utilize some of the features on the ddrum E-Flex kit.

## Using the hi-hat and hi-hat pedal

Press down on the hi-hat pedal to engage the hi-hat sound. (Please see Diagram 2.) For a more loose sound, release the pedal and strike the hi hat pad. For a closed Hi-Hat sound press and hold down the hi-hat pedal while striking the hi-hat pad. (Please see Diagram 3.)

## Using the bass drum pedal

The bass drum pedal is similar to the hi-hat pedal. Press down on the pedal to engage the bass drum sound. The ddrum E-Flex has the option for double bass. Simply hold the up and down arrow buttons until the screen shows "BHH". The hi-hat pedal now functions as second bass drum.

## Using the Ride cymbal

The Ride cymbal offers two playing zones and choke function. The bow or body of the cymbal can be played near the edge of the pad. (Please see Diagram 4.) The bell or second zone can be played by striking the pad near the bell. (Please see Diagram 5.) To use the choke function, grab the pad by the highlighted area shown on Diagram 6.

## Using the Snare drum

All the pads including the snare drum are velocity sensitive. This means the pad reacts to hard and soft strikes just like a real drum. Soft strikes will be low and hard strikes being loud. (Please see Diagram 7.) The snare drum includes a dual zone function which allows two separate sounds from the drum head and rim. (Please see Diagram 8.)



Diagram 2



Diagram 3



Diagram 4

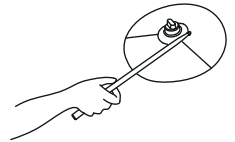

Diagram 5



Diagram 6

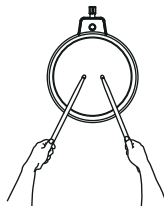

Diagram 7



Diagram 8

# Module Introduction

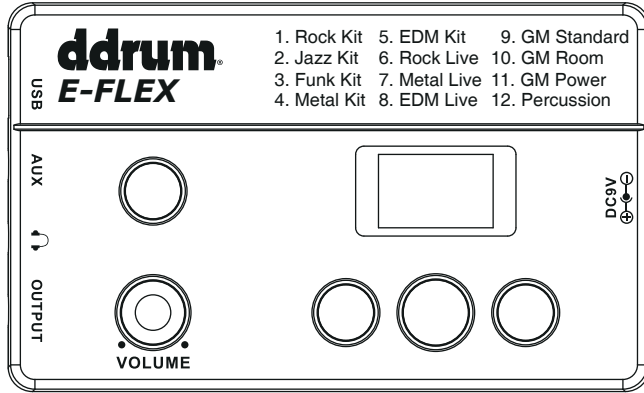

Diagram 9

⏻ Press to turn On power / Press and hold to turn Off power.

"VOLUME" : Control the whole drum kit volume.

🔊 : Metronome On / Off.

"▼" "▲" : Choose drum sound patterns. ( to adjust tempo and beat when the click is on )

"USB" : USB MIDI port ( refer to page 18 for details ).

"AUX" : 3.5mm gauge audio cable input.

🎧 : 3.5mm gauge earphone output.

"OUTPUT" : 3.5mm gauge audio cable output to drum amp.



"DC9V" : Connect to DC9V power adapter ⊕ — ⊖ — ⊖, negative tip.

# How to Operate



## 1. Power and audio cable connection

If you are using the E-Flex with a drum amplifier, be sure to use the audio cable included with the E-Flex. Connect the audio cable from the output on the module to the input on the amplifier. The user also has the option to use headphones. Simply plug into the headphone jack on the module. Be sure to connect the power adapter to the DC 9V port on the module.

## 2. Turn On/Off drum module

Press button  to turn On the machine. Press and hold the button  to turn Off the machine.





## 3. Choose drum kit sound

The ddrum E-Flex kit has 12 preset kit options. Press the "" and "" to scroll through the different drum kits.

Drum kit sound patterns

1 Rock Kit	5 EDM Kit	9 GM Standard
2 Jazz Kit	6 Rock Live	10 GM Room
3 Funk Kit	7 Metal Live	11 GM Power
4 Metal Kit	8 EDM Live	12 Percussion

## 4. Metronome function

1. When the power is on, press button "" into metronome mode, then press "" and "" to adjust the tempo.
2. When in metronome mode, press and hold button "" for 3 seconds to choose beat mode (presets B-4), now press "" or "" button to adjust the beat (1~8);
3. After choosing your ideal beat press "" button, to go back to tempo adjustment mode. press "" again, to choose different sound kits mode.



# Pedal Adjustment and Button Functions

## 1. Pedal adjustment

If you find that the sensitivity of the pedals is different or have changed, please use the button patterns below to adjust the settings.

When Power is OFF, Press and hold “**⏻ + 🎧**” to enter pedal adjustment mode. While the screen is showing “bdF”, press down on the bass drum pedal and hold “**🎧**” until the metronome button shows a green color and then shows an orange color when finished. When the screen shows “HHF” do the same procedure. When the system setup is finished it will light up red and the module will log out of the pedal adjustment mode.

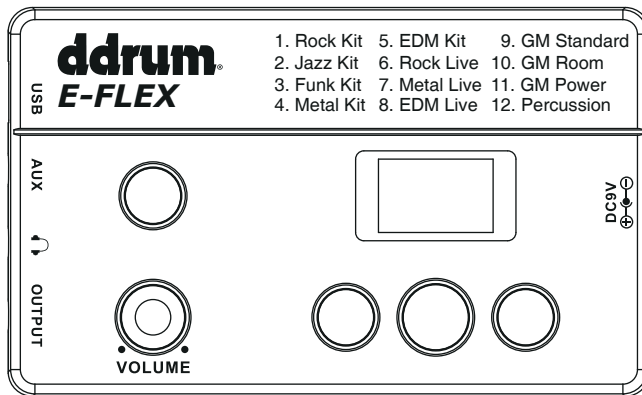

Diagram 10

## 2. Other button pattern functions

1. When the power is off, Press and hold buttons “**⏻ + ▼**” to enter USB Software update function. The screen will show “UPG”. At this time use a USB cable to connect the module to a computer to complete the update.
2. When the power is OFF, Press and hold buttons “**⏻ + ▲**” to enter factory rest. The screen will show “CLR”.
3. When the power is ON, Press and hold button “**🎧**” for 3 Seconds to reference the system version.

## 3. Double Bass Mode

The E-Flex module has an option for double bass playing. To access this mode, press and hold both arrow buttons until the screen shows “BHH”. The Hi-Hat pedal now functions as a second bass drum. The Hi-Hat sound will be open on all preset drum kits when double bass mode is engaged.

# USB MIDI

Connect to your synthesizer or personal computer to play your MIDI music.MIDI ( musical instrument digital interface ) format list.

MIDI:

Function		Transmitted	Recognized	Remarks
Basic Channel	Default	10	1 ~ 8 & 10 ~ 16	
	Changed	x	x	
Mode	Default	x	Mode 3	
	Messages Altered	x *****	x *****	
Note Number		0 ~ 127	0 ~ 127	
	True voice	*****	0 ~ 127	
Velocity	Note ON	0 ~ 127	0 ~ 127	
	Note OFF	x	0 ~ 127	
After Touch	Keyss	x	x	
	Channelss	x	x	
Pitch Bend		x	O	
Control Change	0	x	O	Bank Select
	1	x	O	Modulation
	4	x	O	Foot Control
	5	x	O	Portamento Time
	6	x	O	Data Entry
	7	x	O	Volume
	10	x	O	Pan
	11	x	O	Expression
	64	x	O	Sustain Pedal
	65	x	O	Portamento On/Off
	66	x	O	Sostenuto Pedal
	67	x	O	Soft Pedal
	71	x	O	Resonance
	72	x	O	Release Time
	73	x	O	Attack Time
	74	x	O	Cut Off
80	x	O	Reverb Program	
81	x	O	Chorus Program	
90	x	O	Reverb Level	
91	x	O	Chorus Level	
120	x	O	All Sound OFF	
121	x	O	Reset All Controller *1	
123	x	O	All Notes OFF *1	
Program Change		x	O	
System Exclusive		x	O	
System common	Song Position	x	x	
	Song Select	x	x	
	Tune	x	x	
System Real Time	Clock	x	x	
	Commands	x	x	
Aux Messages	Local ON/OFF	x	x	
	All Notes OFF	x	x	
	Active Sense	O	x	
	Reset	x	x	

Mode 1 : Omni On, Poly Mode 2 : Omni On, Mono  
Mode 3 : Omni Off, Poly Mode 4 : Omni Off, Mono

O : Yes X : No  
Notes \*1 Except 9, 10 Channel

# Specifications

Drum Kit Contents	crash cymbal, hi-hat, ride cymbal, tom drum * 3, snare drum, hi-hat pedal, bass drum pedal	
Drum Sound Kit Quantity	12	
Metronome	Tempo	40-240 BPM
	Beat	1- 8
Control Buttons	Power Button	
	▲ ▼ Button	
	Metronome Button	
	Main Volume Button	0-100
LCD Screen	3 digit numbers by tubes	
Interface	3.5mm gauge audio port	
	3.5mm earphone port	
	3.5mm aux port	
	USB B type MIDI port	
	DB25 drums signal cables	
	AC/DC adapter port	
Power Voltage	DC9V ⊕ ⊖	
Power Current	300mA	
Accessories	Electronic drum kit, Assembly Direction, Operation Manual, AC adapter, Audio cable -1 piece, M6 tool -1 piece, drum sticks -1 pair	
Optional Products	Drum Amp	DDA50 BT
	Headphones	Dimension 1.40 × 1.00m

**Reminder:** Product information is subject o change with out notice.



**FCC Warning:**

This equipment has been tested and found to comply with the limits for a Class B digital device, pursuant to part 15 of the FCC Rules. These limits are designed to provide reasonable protection against harmful interference in a residential installation. This equipment generates, uses and can radiate radio frequency energy and, if not installed and used in accordance with the instructions, may cause harmful interference to radio communications. However, there is no guarantee that interference will not occur in a particular installation. If this equipment does cause harmful interference to radio or television reception, which can be determined by turning the equipment off and on, the user is encouraged to try to correct the interference by one or more of the following measures:

- Reorient or relocate the receiving antenna.
- Increase the separation between the equipment and receiver.
- Connect the equipment into an outlet on a circuit different from that to which there ceiver is connected.
- Consult the dealer or an experienced radio/TV technician for help.

Caution: Any changes or modifications to this device not explicitly approved by manufacturer could void your authority to operate this equipment.

This device complies with part 15 of the FCC Rules. Operation is subject to the following two conditions: (1) This device may not cause harmful interference, and (2) this device must accept any interference received, including interference that may cause undesired operation.

This equipment complies with FCC radiation exposure limits set forth for an uncontrolled environment. This equipment should be installed and operated with minimum distance 20cm between the radiator & your body.



MADE IN CHINA